

INSTALLATION REQUIREMENTS - PRIMED & COLORPLUS® PRODUCTS

**SELECT CEDARMILL® ▪ SMOOTH ▪ COLONIAL SMOOTH® ▪ COLONIAL ROUGHSAWN® ▪ BEADED CEDARMILL®
BEADED SMOOTH ▪ STRAIGHT-EDGE SHINGLE PLANK**

IMPORTANT: FAILURE TO INSTALL AND FINISH THIS PRODUCT IN ACCORDANCE WITH APPLICABLE BUILDING CODES AND JAMES HARDIE WRITTEN APPLICATION INSTRUCTIONS MAY LEAD TO PERSONAL INJURY, AFFECT SYSTEM PERFORMANCE, VIOLATE LOCAL BUILDING CODES, AND VOID THE PRODUCT ONLY WARRANTY. BEFORE INSTALLATION, CONFIRM THAT YOU ARE USING THE CORRECT HARDIEZONE™ PRODUCT INSTRUCTIONS. INSTALLATION OF HZ10® PRODUCTS OUTSIDE AN HZ10® LOCATION WILL VOID YOUR WARRANTY. TO DETERMINE WHICH HARDIEZONE™ APPLIES TO YOUR LOCATION, VISIT WWW.HARDIEZONE.COM OR CALL 1-866-942-7343 (866 9HARDIE)

STORAGE & HANDLING:

Store flat and keep dry and covered prior to installation. Installing siding wet or saturated may result in shrinkage at butt joints. Carry planks on edge. Protect edges and corners from breakage. James Hardie is not responsible for damage caused by improper storage and handling of the product.

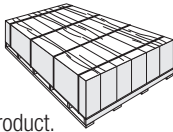

CUTTING INSTRUCTIONS

OUTDOORS

1. Position cutting station so that wind will blow dust away from user and others in working area.
2. Use one of the following methods:
 - a. Best:
 - i. Score and snap
 - ii. Shears (manual, electric or pneumatic)
 - b. Better:
 - i. Dust reducing circular saw equipped with a HardieBlade® saw blade and HEPA vacuum extraction
 - c. Good:
 - i. Dust reducing circular saw with a HardieBlade saw blade (only use for low to moderate cutting)

INDOORS

1. Cut only using score and snap, or shears (manual, electric or pneumatic).
2. Position cutting station in well-ventilated area

- NEVER use a power saw indoors
- NEVER use a circular saw blade that does not carry the HardieBlade saw blade trademark
- NEVER dry sweep – Use wet suppression or HEPA Vacuum

Important Note: For maximum protection (lowest respirable dust production), James Hardie recommends always using "Best"-level cutting methods where feasible.

NIOSH-approved respirators can be used in conjunction with above cutting practices to further reduce dust exposures. Additional exposure information is available at www.jameshardie.com to help you determine the most appropriate cutting method for your job requirements. If concern still exists about exposure levels or you do not comply with the above practices, you should always consult a qualified industrial hygienist or contact James Hardie for further information.

SD083105

GENERAL REQUIREMENTS:

- HardiePlank® lap siding can be installed over braced wood or steel studs spaced a maximum of 24" o.c. or directly to minimum 7/16" thick OSB sheathing. Irregularities in framing and sheathing can mirror through the finished application.
- HardiePlank® lap siding can also be installed over foam insulation/sheathing up to 1" thick. When using foam insulation/sheathing, avoid over-driving nails (fasteners), which can result in dimpling of the siding due to the compressible nature of the foam insulation/sheathing. Extra caution is necessary if power-driven nails (fasteners) are used for attaching siding over foam insulation/sheathing.
- A water-resistive barrier is required in accordance with local building code requirements. The water-resistive barrier must be appropriately installed with penetration and junction flashing in accordance with local building code requirements. James Hardie will assume no responsibility for water infiltration. James Hardie does manufacture HardieWrap® Weather Barrier, a non-woven non-perforated housewrap¹, which complies with building code requirements.
- When installing James Hardie products all clearance details in figs. 3,4,5,6,7,8,&9 must be followed.
- Adjacent finished grade must slope away from the building in accordance with local building codes - typically a minimum of 6" in the first 10'.
- Do not use HardiePlank lap siding in fascia or trip applications.
- Do not install James Hardie products, such that they may remain in contact with standing water.
- HardiePlank lap siding may be installed on flat vertical wall applications only.
- For larger projects, including commercial and multi-family projects, where the span of the wall is significant in length, the designer and/or architect should take into consideration the coefficient of thermal expansion and moisture movement of the product in their design. These values can be found in the Technical Bulletin "Expansion Characteristics of James Hardie® Siding Products" at www.JamesHardie.com.
- DO NOT use stain on James Hardie® products.

INSTALLATION:

JOINT TREATMENT*

(Required for ColorPlus® Finish, Recommended for Primed product)

James Hardie does not recommend the use of caulk at field butt joints.

Figure 2

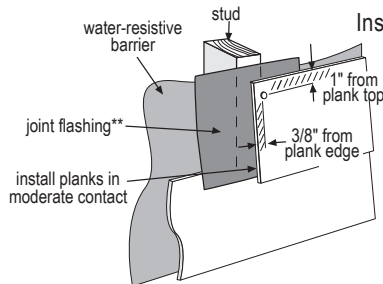

Install factory finished edges together at butt joints.

Figure 1 Double Wall Construction

Single Wall Construction

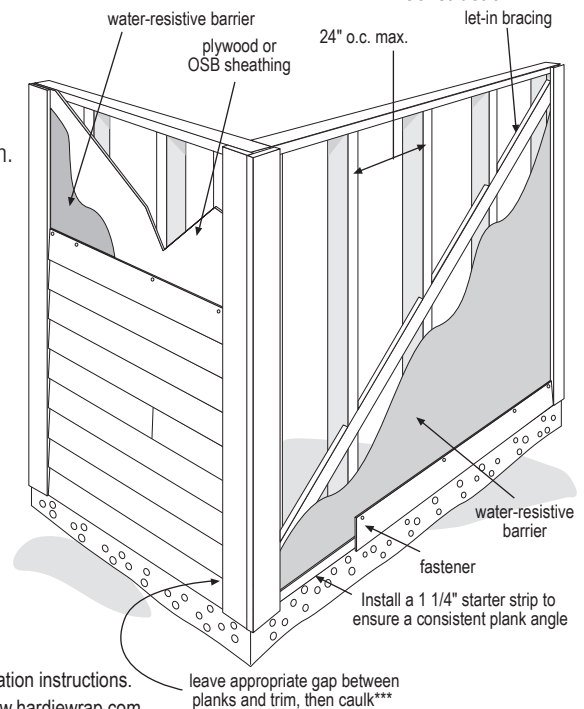

*For other jointing options, refer to local building code or NER 405

As required by local building code *Apply caulk in accordance with caulk manufacturers written application instructions.

¹For additional information on HardieWrap® Weather Barrier, consult James Hardie at 1-866-4Hardie or www.hardiewrap.com

WARNING: AVOID BREATHING SILICA DUST

James Hardie® products contain respirable crystalline silica, which is known to the State of California to cause cancer and is considered by IARC and NIOSH to be a cause of cancer from some occupational sources. Breathing excessive amounts of respirable silica dust can also cause a disabling and potentially fatal lung disease called silicosis, and has been linked with other diseases. Some studies suggest smoking may increase these risks. During installation or handling: (1) work in outdoor areas with ample ventilation; (2) use fiber cement shears for cutting or, where not feasible, use a HardieBlade® saw blade and dust-reducing circular saw attached to a HEPA vacuum; (3) warn others in the immediate area; (4) wear a properly-fitted, NIOSH-approved dust mask or respirator (e.g. N-95) in accordance with applicable government regulations and manufacturer instructions to further limit respirable silica exposures. During clean-up, use HEPA vacuums or wet cleanup methods - never dry sweep. For further information, refer to our installation instructions and Material Safety Data Sheet available at www.jameshardie.com or by calling 1-800-9HARDIE (1-800-942-7343). FAILURE TO ADHERE TO OUR WARNINGS, MSDS, AND INSTALLATION INSTRUCTIONS MAY LEAD TO SERIOUS PERSONAL INJURY OR DEATH.

SD050905

CLEARANCES

Install siding and trim products in compliance with local building code requirements for clearance between the bottom edge of the siding and the adjacent finished grade.

Figure 3

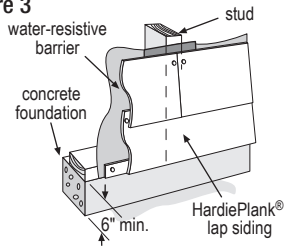

Maintain a 1/4" clearance between the bottom of James Hardie products and horizontal flashing. Do not caulk gap.

Figure 7

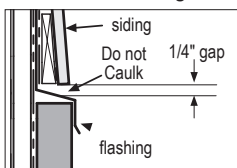

Maintain a 1" - 2" clearance between James Hardie® products and paths, steps and driveways.

Figure 4

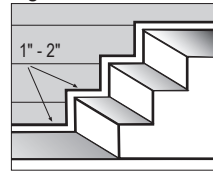

Maintain a minimum 1" gap between gutter end caps and siding & trim.

Figure 8

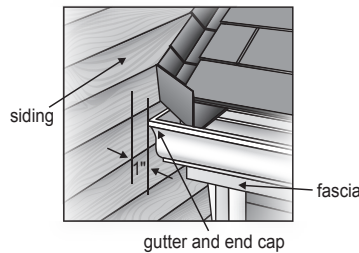

Maintain a 1" - 2" clearance between James Hardie products and decking material.

Figure 5

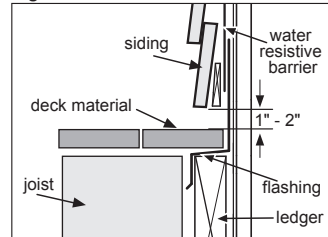

At the juncture of the roof and vertical surfaces, flashing and counterflashing shall be installed per the roofing manufacturer's instructions. Provide a 1" - 2" clearance between the roofing and the bottom edge of the siding and trim.

Figure 6

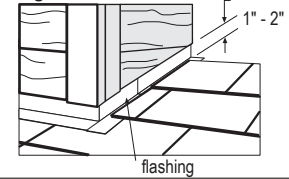
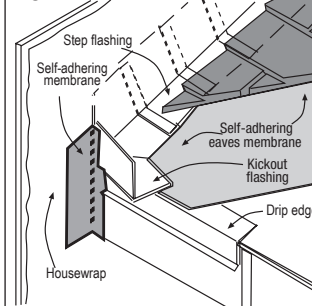

Figure 9



KICKOUT FLASHING

Because of the volume of water that can pour down a sloped roof, one of the most critical flashing details occurs where a roof intersects a sidewall. The roof must be flashed with step flashing. Where the roof terminates, install a kickout to deflect water away from the siding.

It is best to install a self-adhering membrane on the wall before the subsfascia and trim boards are nailed in place, and then come back to install the kickout.

Figure 9, Kickout Flashing[†] To prevent water from dumping behind the siding and the end of the roof intersection, install a "kickout" of sufficient length and angle to direct the water running down the roof away from the siding.

FASTENER REQUIREMENTS **

Blind Nailing is the preferred method of installation for all HardiePlank® lap siding products

BLIND NAILING

Nails - Wood Framing

- Siding nail (0.09" shank x 0.221" HD x 2" long)
- 11ga. roofing nail (0.121" shank x 0.371" HD x 1.25" long)

Screws - Steel Framing

- Ribbed Wafer-head or equivalent (No. 8 x 1 1/4" long x 0.375" HD) Screws must penetrate 3 threads into metal framing.

Nails - Steel Framing

- ET & F Panelfast® nails or equivalent (0.10" shank x 0.313" HD x 1-1/2" long) Nails must penetrate minimum 1/4" into metal framing.

OSB minimum 7/16"

- 11ga. roofing nail (0.121" shank x 0.371" HD x 1.75" long)
- Ribbed Wafer-head or equivalent (No. 8 x 1 5/8" long x 0.375" HD).

FACE NAILING

Nails - Wood Framing

- 6d (0.113" shank x 0.267" HD x 2" long)
- Siding nail (0.09" shank x 0.221" HD x 2" long)

Screws - Steel Framing

- Ribbed Bugle-head or equivalent (No. 8-18 x 1-5/8" long x 0.323" HD) Screws must penetrate 3 threads into metal framing.

Nails - Steel Framing

- ET & F pin or equivalent (0.10" shank x 0.25" HD x 1-1/2" long) Nails must penetrate minimum 1/4" into metal framing.

OSB minimum 7/16"

- Siding nail (0.09" shank x 0.221" HD x 1-1/2" long)*

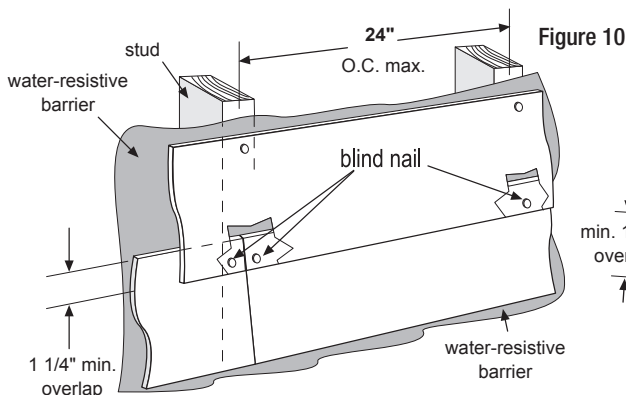

Figure 10

Minimum overlap for Both Face and Blind Nailing

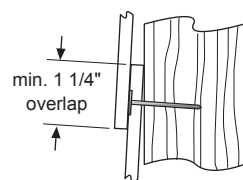
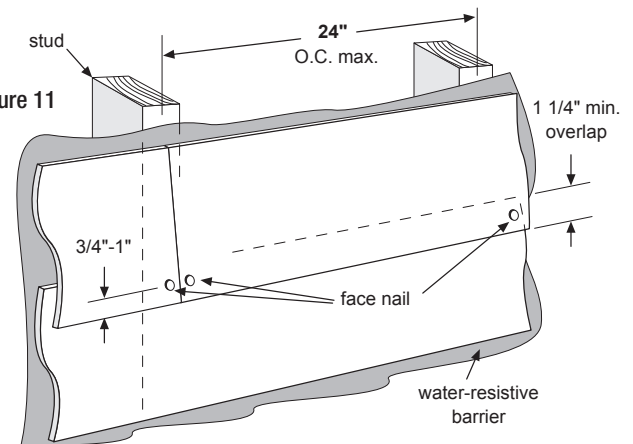

Figure 11



Laminate sheet to be removed immediately after installation of each course for ColorPlus® products.

[†] The illustration (figure 9) and associated text was reprinted with permission of THE JOURNAL OF LIGHT CONSTRUCTION. For subscription information, visit www.jlconline.com.

* When face nailing to OSB, planks must be no greater than 9 1/4" wide and fasteners must be 12" o.c. or less.

** Also see General Fastening Requirements; and when considering alternative fastening options refer to James Hardie's Technical Bulletin USTB 17 - Fastening Tips for HardiePlank® Lap Siding.

GENERAL FASTENING REQUIREMENTS

Fasteners must be corrosion resistant, galvanized, or stainless steel. Electro-galvanized are acceptable but may exhibit premature corrosion. James Hardie recommends the use of quality, hot-dipped galvanized nails. James Hardie is not responsible for the corrosion resistance of fasteners. Stainless steel fasteners are recommended when installing James Hardie® products near the ocean, large bodies of water, or in very humid climates.

PNEUMATIC FASTENING

James Hardie products can be hand nailed or fastened with a pneumatic tool. Pneumatic fastening is highly recommended. Set air pressure so that the fastener is driven snug with the surface of the siding. A flush mount attachment on the pneumatic tool is recommended. This will help control the depth the nail is driven. If setting the nail depth proves difficult, choose a setting that under drives the nail. (Drive under driven nails snug with a smooth faced hammer - Does not apply for installation to steel framing).

- Consult applicable code compliance report for correct fasteners type and placement to achieve specified design wind loads.
- NOTE: Published wind loads may not be applicable to all areas where Local Building Codes have specific jurisdiction. Consult James Hardie Technical Services if you are unsure of applicable compliance documentation.
- Drive fasteners perpendicular to siding and framing.
- Fastener heads should fit snug against siding (no air space). (fig. A)
- Do not over-drive nail heads or drive nails at an angle.
- If nail is countersunk, caulk nail hole and add a nail. (fig. B)
- For wood framing, under driven nails should be hit flush to the plank with a hammer (For steel framing, remove and replace nail).
- **Do not use aluminum fasteners, staples, or clipped head nails.**

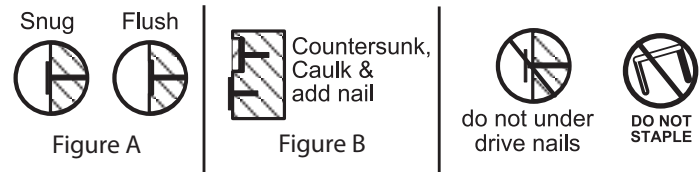

CAULKING

For best results use an Elastomeric Joint Sealant complying with ASTM C920 Grade NS, Class 25 or higher or a Latex Joint Sealant complying with ASTM C834. Caulking/Sealant must be applied in accordance with the caulking/sealant manufacturer's written instructions or ASTM C1193.

PAINTING

DO NOT use stain on James Hardie® products. James Hardie products must be painted within 180 days for primed product and 90 days for unprimed. 100% acrylic topcoats are recommended. Do not paint when wet. For application rates refer to paint manufacturers specifications. Back-rolling is recommended if the siding is sprayed.

COLORPLUS® TECHNOLOGY CAULKING, TOUCH-UP & LAMINATE

- Touch up nicks, scrapes and nail heads using the ColorPlus® Technology touch-up applicator. Touch-up paint should be used sparingly. If large areas require touch-up, replace the damaged area with new HardiePlank® lap siding with ColorPlus Technology.
- Laminate sheet must be removed immediately after installation of each course.
- Terminate non-factory cut edges into trim where possible, and caulk. Color matched caulks are available from your ColorPlus® product dealer.
- Treat all other non-factory cut edges using the ColorPlus Technology edge coat, available from your ColorPlus product dealer.

PAINTING JAMES HARDIE® SIDING AND TRIM PRODUCTS WITH COLORPLUS® TECHNOLOGY

When repainting ColorPlus products, James Hardie recommends the following regarding surface preparation and topcoat application:

- Ensure the surface is clean, dry, and free of any dust, dirt, or mildew
- Repriming is normally not necessary
- 100% acrylic topcoats are recommended
- DO NOT use stain or oil/alkyd base paints on James Hardie® products
- Apply finish coat in accordance with paint manufacturers written instructions regarding coverage, application methods, and application temperature

COVERAGE CHART/ESTIMATING GUIDE

Number of 12' planks, does not include waste

COVERAGE AREA LESS OPENINGS	HARDIEPLANK® LAP SIDING WIDTH										
	SQ (1 SQ = 100 sq.ft.)	(exposure)	5 1/4 4	6 1/4 5	7 1/4 6	7 1/2 6 1/4	8 6 3/4	8 1/4 7	9 1/4 8	9 1/2 8 1/4	12 10 3/4
1			25	20	17	16	15	14	13	13	9
2			50	40	33	32	30	29	25	25	19
3			75	60	50	48	44	43	38	38	28
4			100	80	67	64	59	57	50	50	37
5			125	100	83	80	74	71	63	63	47
6			150	120	100	96	89	86	75	75	56
7			175	140	117	112	104	100	88	88	65
8			200	160	133	128	119	114	100	100	74
9			225	180	150	144	133	129	113	113	84
10			250	200	167	160	148	143	125	125	93
11			275	220	183	176	163	157	138	138	102
12			300	240	200	192	178	171	150	150	112
13			325	260	217	208	193	186	163	163	121
14			350	280	233	224	207	200	175	175	130
15			375	300	250	240	222	214	188	188	140
16			400	320	267	256	237	229	200	200	149
17			425	340	283	272	252	243	213	213	158
18			450	360	300	288	267	257	225	225	167
19			475	380	317	304	281	271	238	238	177
20			500	400	333	320	296	286	250	250	186

This coverage chart is meant as a guide. Actual usage is subject to variables such as building design. James Hardie does not assume responsibility for over or under ordering of product.

RECOGNITION: In accordance with ICC-ES Legacy Report NER-405, HardiePlank® lap siding is recognized as a suitable alternate to that specified in: the BOCA National Building Code/1999, the 1997 Standard Building Code, the 1997 Uniform Building Code, the 1998 International One- and Two-Family Dwelling Code, the 2003 International Building Code, and the 2003 International Residential Code for One- and Two-Family Dwellings. HardiePlank lap siding is also recognized for application in the following: City of Los Angeles Research Report No. 24862, State of Florida listing FL#889, Dade County, Florida NOA No. 02-0729.02, U.S. Dept. of HUD Materials Release 1263c, Texas Department of Insurance Product Evaluation EC-23, City of New York MEA 223-93-9M, and California DSA PA-019. These documents should also be consulted for additional information concerning the suitability of this product for specific applications.

